

Series DR 100

3-port Miniature Solenoid Valve

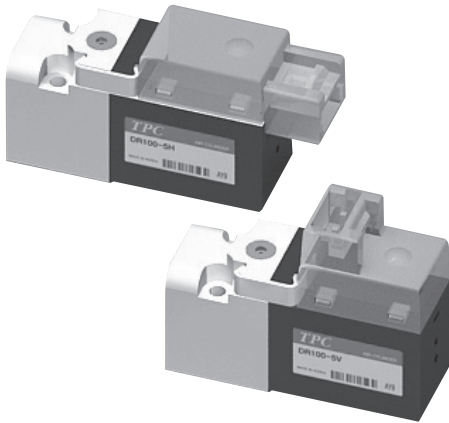

- SUBCOMPACT (100MM WIDE) TYPE VALVE
- SUPERB UTILIZATION CONDITION IN HIGH PRESSURE (MAX' 0.8MPa)
- LARGE FLUX GUARANTEED (SUPPLY/EXHAUST=18/20ℓ /min)
- UPGRADE IMPACT-RESISTANCE VIBRATION-RESISTANCE PERFORMANCE
- VISUAL DISTANCE GUARANTEED BY LED LAMP (LAMP WINDOW LENS EQUIPPED, HIGH BRIGHTNESS LED APPLIED)
- MINIMIZED THERMAL DEFORMATION AND E/PLASTIC WITH EXCELLENT DIMENSION STABILITY APPLIED, FLUORINE SERIES SEALING SYSTEM APPLIED WHICH HAS HIGH PERFORMANCE IN HIGH TEMPERATURE.
- LOW ELECTRIC CONSUMPTION TYPE (OPTION ENERGY CONSERVATION TYPE)

Symbol

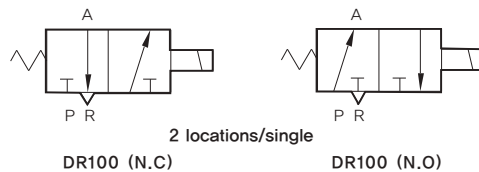

How to Order

DR 100 — 5 H N — M5 — XWL * *

1
2
3
4
5
6

1 DR100 Series

Subcompact type (10mm wide)
3 port valve
100 : N.C Type
120 : N.O Type

2 Voltage

1 : AC110V
2 : AC220V
5 : DC24V
6 : DC12V
*AC110V, AC220V are only for Vertical type.

3 Electrical Entry (DC, AC)

V : Vertical type connector
H : Horizontal type connector

*Contact for standard and terminal type.

4 PCB Type

Blank : Standard type (Lamp Type)
N : Lead wire excluded
D : Non-polar lamp type
S : Power saving PCB Type
(0.85 → 0.45W)

*Application range of D,S is V and H types of DC only.

5 Option

Blank : Without sub-plate
M5 : With sub-plate (M5×0.8)

6 Length of Lead Wire

Blank : 300mm
XWL01 : 100mm
XWL02 : 200mm
XWL04 : 400mm

Specifications

DR Series		DR100	DR120
Applied Fluid		Air	
Applied Pressure Range		0~0.7(0~7)	
Operating Method		N.C Type	N.O Type
Ambient Temperature and Applied Fluid Temperature (°C)		Maximum 50	
Allowable Voltage Fluctuation (%)		-10~+10 of Voltage	
Maximum Operating Frequency (Hz)	DC	20	10
	AC	15	5
Minimum Operating Frequency		1 Time / 30 Days	
Lubrication		Not Required	
Impact-Resistance/Vibration-Resistance (m/s ²)		300 / 50	
Protecting Structure		Vibration-Resistance	
Mounting Position		Free	
Manual Override		NON LOCK PUSH Type	
Lead Track Extracting Method and Color		DC / Horizontal Type, Vertical Type (+ : Red, - : Black)	
Rated Voltage (V)	DC	12V, 24V	
	AC	110V, 220V	
Effective Sectional Area mm ² (ℓ / min)		Supply(P→A) : 0.28(18), Exhaust(A→R) : 0.3(20)	
Power (W)		Standard : 0.85 or Less (Lamp Attached, Rated Voltage Approved) Power Saving : 0.45 or Less	
Response Time (ms)		Less Than 10 in Common (0.5MPa base)	

Dimensions (DR100 Series)

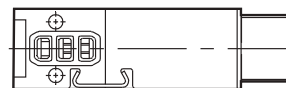
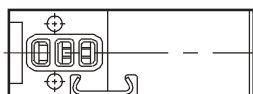
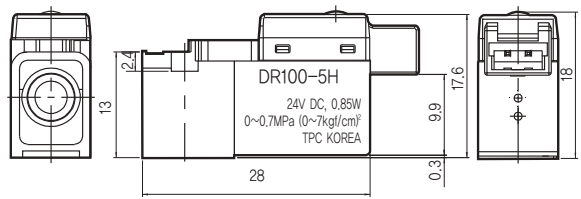
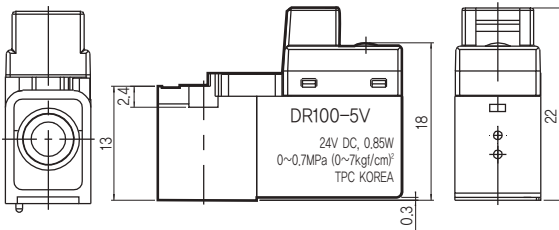
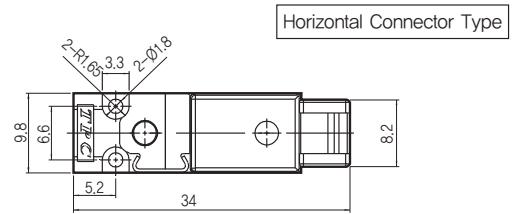
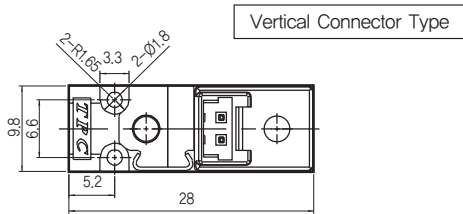

DW

DR100

DR200

RS1000,
2000

RS4000

SI UNIT

DV1000
DV3000
DV4000

DS300

DS3000

DS5000

DS2000

DS6000

DX1,DX2

DX1(2)R

DH

DP300
DP3000
DP5000

DM

DT220

Series DR 100

Dimensions (DR100 Series Sub-Plate Type)

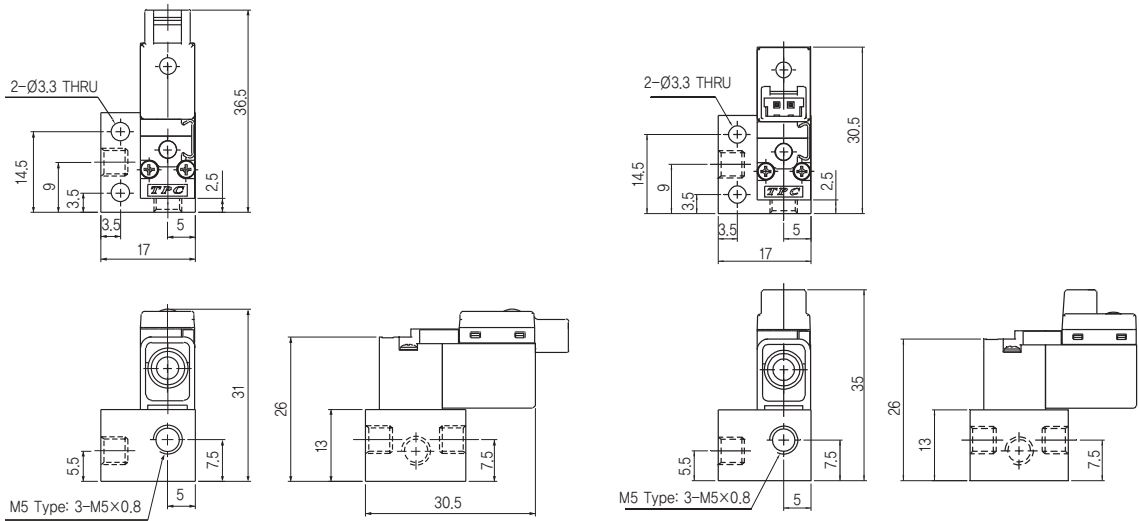

Manifold

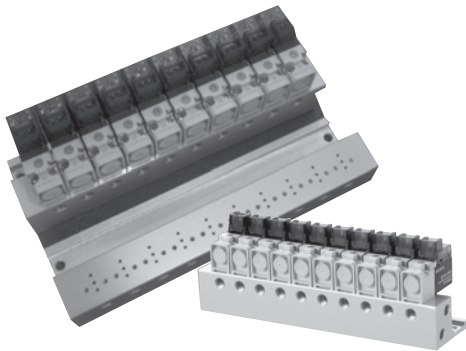

How to Order

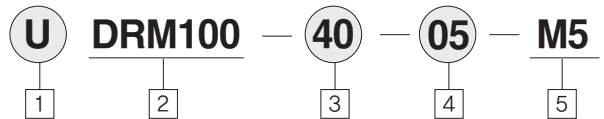

1 Blank : Rc(PT)
U : NPT

2 Manifold for DR100 Series
10mm body size valve

3 Manifold Specifications
40 : Base mounted

4 Stations
02 : 2 stations
03 : 3 stations
10 : 10 station
:
20 : 20 station

5 Port Size
M5:M5x0.8

Exterior shape dimension drawing (DRM100)

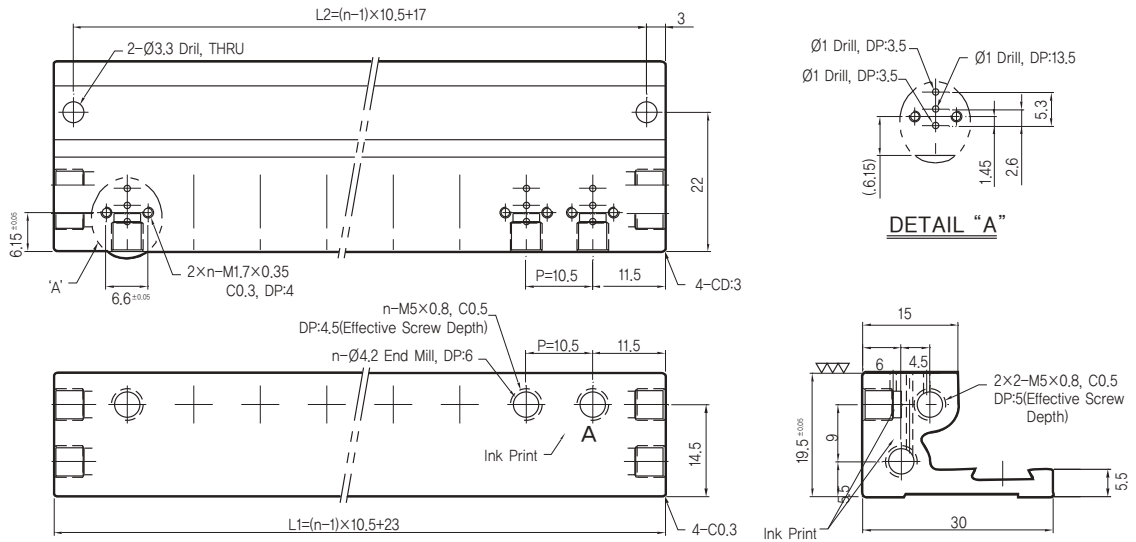

* In case of using DR120 (N/O), please replace P and R of manifold for use. (n=Connection Number)

n	2	3	4	5	6	7	8	9	10	11	12	13	14	15	16	17	18	19	20
L1	33.5	44	54.5	65	75.5	86	96.5	107	117.5	128	135.5	149	159.5	170	180.5	191	201.5	212	222.5
L2	27.5	38	48.5	59	69.5	80	90.5	101	111.5	122	132.5	143	153.5	164	174.5	185	195.5	206	216.5

△ Notice for Product

User must fully understand the notice herein. Refer to a preface for notice and common notice contents for use.

△ Warning

- Manual (Non-lock push type) operation
Since manual operation runs installed equipment, it should be utilized after checking danger parameters.

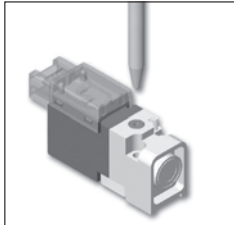

△ Notice

- Do not use sharp end device to manipulate manual.
- Do not apply overload when pushing manual.

- Lead track length of plug connector
The length of plug connector lead track is approximately 300m.
- Surge voltage protection circuit → PCB circuit (H and V type plug connector type)
(1) DC Type
 - Standard type (Lamp attached) → As a standard type, possible to use for any side, but should be cautious of polarity for turning on the lamp
 - Non-polar type (Lamp attached) → Non-polar type, possible to use for any side
 - Energy saving type (Lamp and voltage protection circuit attached) → should be cautious of polarity



● Notice

Refer to DV Series of Basic notices

Polar Type

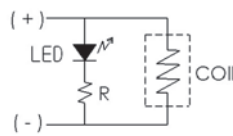

Non-Polar Type

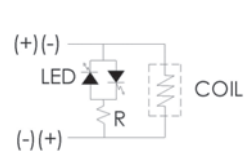

Energy Saving Type

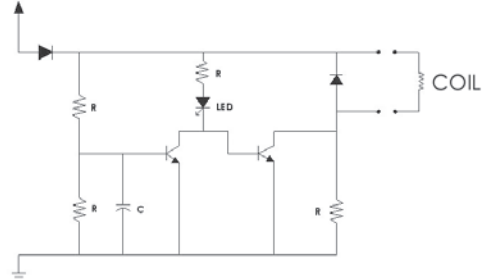

DW

DR100

DR200

RS1000, 2000

RS4000

SI UNIT

DV1000

DV3000

DV4000

DS300

DS3000

DS5000

DS2000

DS6000

DX1,DX2

DX1(2)R

DH

DP300

DP3000

DP5000

DM

DT220