

Series AS

Standard Type/Double Acting, Single Acting : Single Rod

Bore Size(mm) : Ø20, Ø25, Ø30, Ø40

- SUPERIOR LIFE
- POSITION SENSORS
- CORROSION RESISTANT ALUMINUM

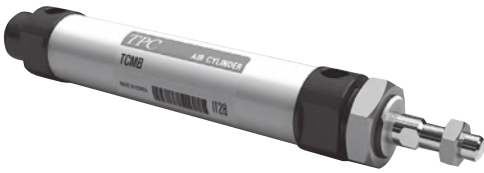

Symbol

Double Acting

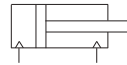

Single Acting



(Spring Extended type)

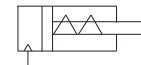

(Spring Return type)

How to Order

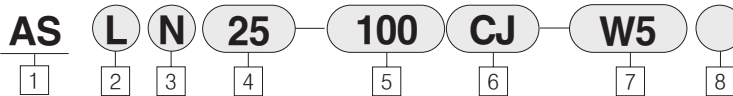

1 Air Cylinder
Standard (Built-in magnet)

2 Mounting
B : Basic
L : Foot Mount
F : Front flange
G : Rear flange
C : Single clevis
D : Double clevis
T : Rear trunnion
U : Front trunnion

3 Type
Blank : Lubricated
N : Non-lube
H : Air-hydro
A : Air-cushion
(Non-lube type standard)

4 Bore Size (mm)

20 : Ø 20
25 : Ø 25
30 : Ø 30
40 : Ø 40

5 Stroke (mm)

Type	Bore Size (mm)	Standard Stroke (mm)
Double Acting	20, 25	25, 50, 75, 100, 125
	30, 40	150, 200, 250, 300
Single Acting	20, 25	25, 50, 75, 100, 125, 150
	30	25, 50, 75, 100, 125, 150, 200
	40	50, 75, 100, 125, 150, 200, 250

6 Suffix Symbol for Cylinder

Rod Boot J : Nylon tarpaulin
K : Neoprene cloth
Action S : Single(Return type)
J : Single(Return type)
T : Single(Extended type)

Cushion C : Rubber cushion(1)
* Single acting type cannot be accepted
★ Suffix in alphabetical sequence when more than two symbols are required.

(1) Not Available with Air Mydro type(H)

* When knuckles are ordered,
I : Single knuckle attached
Y : Double knuckle attached

7 Auto Switch

Blank : None
W5 : Reed Switch, 0.5m Lead Wire
W5L : Reed Switch, 3m Lead Wire

8 Number of Auto Switches

Blank : 2 pcs
S : 1 pc
N : N pcs

- ACP
- APM
- AS**
- AX
- AM2
- AM
- AL
- ALX
- AQ
- ADQ
- AQ2
- ADQ2
- AJ
- AJM
- ABK
- ACK1
- NSK
- AG
- NGQ
- AGX
- GX
- NP
- ADR
- AMR
- NDM
- ARD
- NST
- AST
- ASTH
- NLCD
- NLCS

Series AS

Base Material And Surface Treatment

Description		Material	Surface treatment Anodized
Rod cover		Aluminum alloy	Hard black alumite
Cylinder tube		Aluminum alloy	Hard alumite
Seal area	Lube	NBR	O ring
	Non-lube	NBR	DRP(NSD)
	Air-hydro	NBR	DYR
Piston rod		※ Carbon steel	Hard chrome plated
Piston		Aluminum alloy	Chromate

※ With Auto Switch(ϕ 20, 25) : Stainless steel

Model

Model	Type	Action	Cushion			Seal
			None	Rubber	Air	
AS	Lubricated	Double	○	○	-	O-ring
		Single	○	-	-	
AS○N	Non-lube	Double	○	○	○	Special
		Single	○	-	-	
AS○H	Air-hydro	Double	○	-	-	Special

Specifications

Type		Lubricated, Non-lube	Air-hydro
Fluid		Air	L.P Oil
Proof pressure		1.5MPa (213psi)	
Max. operating pressure		1.0MPa (140psi)	
Min. Operating Pressure	Double acting	0.05MPa(7psi)	0.18MPa(25psi)
	Single acting	0.18MPa(25psi)	-
Ambient and fluid temperature		5~60℃ (40~140°F)	
Piston speed		50~500 mm/s	0.5~300 mm/s
Cushion		None(Rubber Cushion, Air Cushion Optional)	
Stroke tolerance (mm)		~250 st : $+1.0_0$, 251~500 st : $+1.4_0$	
Mounting		Basic, Foot, Front flange, Rear flange, Single clevis, Double clevis, Rear trunnion, Front trunnion	

Parts No. of Mounting Bracket

Bore Size (mm)	20	25	30	40
Foot	TCML20	TCML30	TCML30	TCML40
Flange	TCMF20	TCMF30	TCMF30	TCMF40
Single clevis	TCMC20	TCMC30	TCMC30	TCMC40
Double clevis	TCMD20	TCMD30	TCMD30	TCMD40
Trunnion	TCMT20	TCMT30	TCMT30	TCMT40

Rod Boot/Material

Model	Material	Max. ambient temperature
J	Nylon tarpaulin	60℃(140°F)
K	Neoprene Cloth	※ 110℃(230°F)

※ Maximum ambient temperature for the rod boot only.

Series AS

With Air Cushion Type/AS ○ A

Built-in air cushion mechanism in both end covers can absorb shock at high loads and velocity, giving little or no ambient vibration and resulting in long cylinder life.

Specifications

Feature	Non-Lubrication type
Bore Size	φ 20, φ 25, φ 30, φ 40
Operating type	Double acting
Max. Operating pressure	1.0Mpa(140psi)
Min. Operating Pressure	0.05Mpa(7psi)
Piston Speed	1,000mm/s

Cushion

Bore Size(mm)	Effective length mm(in)	Cross sectional area cm ² (in ²)	Kinetic energy absorption kgf-cm(lbf-in)
φ 20	11(0.433)	2.01(0.312)	4.9(4.25)
φ 25	11(0.433)	3.37(0.522)	7.7(6.68)
φ 30	10(0.394)	5.53(0.857)	10.8(9.37)
φ 40	12.3(0.484)	9.42(1.460)	25(21.7)

※Dimensions and mounting band : Same as Series AS/Double acting type.

With Rubber Cushion Type / AS

Feature	Lubrication Non lube
Operating	Double Acting
Max. Operating Pressure	1MPa(140psi)
Min. Operating Pressure	0.05MPa(7psi)
Piston Speed	750mm/s

Weight/Double Acting

Bore size (mm)		kgf(lbf)			
		20	25	30	40
Basic Weight	Basic	0.18(0.40)	0.27(0.57)	0.30(0.66)	0.72(1.59)
	Foot	0.29(0.64)	0.38(0.84)	0.42(0.93)	0.92(2.03)
	Flange	0.21(0.44)	0.31(0.66)	0.34(0.75)	0.78(1.70)
	Single clevis	0.21(0.44)	0.29(0.64)	0.33(0.71)	0.76(1.68)
	Double clevis	0.21(0.44)	0.29(0.64)	0.34(0.73)	0.77(1.70)
	Trunnion	0.21(0.44)	0.31(0.68)	0.34(0.75)	0.76(1.68)
Additional weight for each 50 of stroke		0.06(0.13)	0.08(0.18)	0.09(0.20)	0.15(0.33)
Metal accessories	Single knuckle joint	0.06(0.13)	0.07(0.13)	0.07(0.13)	0.23(0.51)
	Double knuckle joint(With pin)	0.08(0.15)	0.08(0.15)	0.08(0.15)	0.21(0.44)

Example

ASL30-100

- Basic weight 0.93(Foot · φ 30)
 - Additional weight 0.20/50*
 - Stroke 100*
- 0.93+0.2×100/50=1.33lbf

ACP

APM

AS

AX

AM2

AM

AL
ALX

AQ
ADQ

AQ2
ADQ2

AJ
AJM

ABK

ACK1

NSK

AG

NGQ

AGX
GX

NP

ADR

AMR

NDM

ARD

NST

AST

ASTH

NLCD

NLCS

Series AS

Weight/Single Acting		kgf(lbf)			
Bore size (mm)		φ 20	φ 25	φ 30	φ 40
Basic Weight	25st	0.23	0.34	0.42	0.92
	50st	0.31	0.43	0.54	1.00
	75st	0.39	0.55	0.68	1.18
	100st	0.47	0.65	0.85	1.37
	125st	0.57	0.73	0.98	1.61
	150st	0.65	0.82	1.12	1.81
	200st	-	-	1.40	2.19
Mounting metals	Foot	0.16	0.17	0.17	0.32
	Flange	0.07	0.08	0.08	0.17
Weight	Single clevis	0.07	0.06	0.06	0.15
	Double clevis	0.07	0.07	0.07	0.16
Accessories	Trunnion	0.07	0.09	0.08	0.16
	Single knuckle joint	0.07	0.06	0.06	0.23
	Double knuckle joint(With Pin)	0.08	0.07	0.07	0.20

Precautions

- When mounting, completely flush the piping and be careful that dust and chips do not enter the cylinder.
- Load of piston rod should always be aligned parallel with the cylinder axis.
- Avoid damage (scratches, nicks) to the piston rod, that lead to damage of rod seal, resulting air leakage.
- When disassembling, hold one head cover on the flats in a vise while gripping the opposite cover on the flats with a spanner and turning counterclockwise.

<Lube Type>

- L.P. Oil : Use non-additive turbine oil ISO-VG32. Never use machine oil or spindle oil.

<Air-Hydro Type>

- L.P. Oil : Use ISO VG22-46 or equivalent L.P. Oil. Never use machine oil spindle oil.
- Air contamination : When lubricating, be careful not to let any air in. Since L.P. Oil Type is not equipped with air exhaust valve, air should be let out beforehand, loosening of the fitting screwed into piping ports.

Example

ASL30-100S

(Basic weight) 0.85+ (Mounting weight) 0.16=1.01kgf

Double Acting/Basic Type(ASB)

Lube Type(ASB), Non-Lube Type(ASBN), Air-Hydro Type(ASBH)

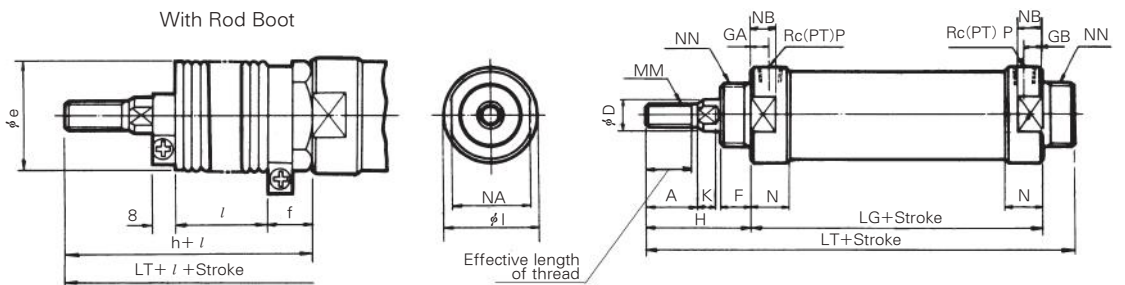

Bore size (mm)	Stroke range (mm)	Effective length of thread	A	φ D	F	GA	GB	φ I	K	MM	N	NA	NB	NN	P Rc(PT)	LG
φ 20	~300	15.5	18	10	13	8	8	28	5.0	M8×1.25	15	24	13	M20×1.5	1/8	62
φ 25	~300	19.5	22	12	13	8	8	34	5.5	M10×1.25	15	30	13	M26×1.5	1/8	62
φ 30	~300	19.5	22	12	13	8	8	38	5.5	M10×1.25	15	32	13	M26×1.5	1/8	64
φ 40	~300	21.0	24	16	16	11	11	50	7.5	M14×1.5	21	46	19	M32×2.0	1/4	88

With Rubber Cushion

Bore size (mm)	Without Rod Boot		With Rod Boot					Without Rod Boot			With Rod Boot
	H	LT	φ e	f	h	l	LT	LG	LT	LT	
φ 20	41	116	36	14	56		131	68	122	137	
φ 25	45	120	36	14	60	0.3 Stroke+3	135	68	126	141	
φ 30	45	122	36	14	60		137	70	128	143	
φ 40	50	154	40	16	67	0.25 Stroke+3	171	94	160	177	

※ Minimum stroke with : 20mm or more

Series AS

Single Acting/Basic Type

Lube Type(ASB), Non-Lube Type(ASBN)

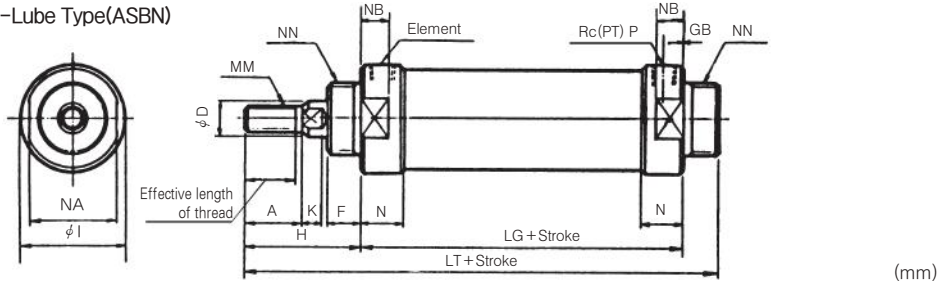

Bore size (mm)	Stroke range (mm)	Effective length thread	A	φD	F	GB	I	K	MM	N	NA	NB	NN	P	H
φ 20	~150	15.5	18	10	13	8	28	5	M8×1.25	15	24	13	M20×1.5	1/8	41
φ 25	~150	19.5	22	12	13	8	34	5.5	M10×1.25	15	30	13	M26×1.5	1/8	45
φ 30	~200	19.5	22	12	13	8	38	5.5	M10×1.25	15	32	13	M26×1.5	1/8	45
φ 40	~250	21.0	24	16	16	11	50	7.5	M14×1.5	21	46	19	M32×2.0	1/4	50

Bore size (mm)	1~25ST		26~50ST		51~75ST		76~100ST		101~125ST		126~150ST		151~200ST		201~250ST	
	LG	LT	LG	LT	LG	LT	LG	LT	LG	LT	LG	LT	LG	LT	LG	LT
φ 20	84	138	102	156	126	180	144	198	169	223	194	248	-	-	-	-
φ 25	82	140	97	155	119	177	134	192	144	202	159	217	-	-	-	-
φ 30	87	145	104	162	124	182	150	208	167	225	187	245	227	285	-	-
φ 40	123	189	123	189	136	202	153	219	174	240	191	257	221	287	246	312

Double Acting (Foot/ASL○)

Lube Type(ASL), Non-Lube Type(ASLN), Air-Hydro Type(ASLH)

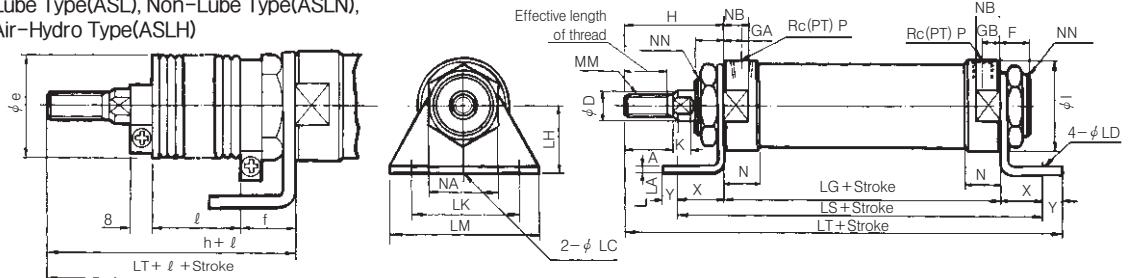

Bore size (mm)	*Stroke range (mm)	Effective length thread	A	φD	F	GA	GB	φI	K	MM	N	NA	NB	NN	P	LG
φ 20	~400	15.5	18	10	13	8	8	28	5.0	M8×1.25	15	24	13	M20×1.5	1/8	62
φ 25	~450	19.5	22	12	13	8	8	34	5.5	M10×1.25	15	30	13	M26×1.5	1/8	62
φ 30	~450	19.5	22	12	13	8	8	38	5.5	M10×1.25	15	32	13	M26×1.5	1/8	64
φ 40	~500	21.0	24	16	16	11	11	50	7.5	M14×1.5	21	46	19	M32×2.0	1/4	88

* Minimum stroke with Rod Boot : 20mm or more.

Bore size (mm)	X	Y	LC	LD	LH	LS	LA	LK	LM	With Rubber Cushion													
										Without Rod Boot		With Rod Boot						Without Rod Boot				With Rod Boot	
										H	LT	φe	f	h	ℓ	LT	LG	LS	LT	LT			
φ 20	20	8	4	6.8	25	102	3.2	40	55	41	131	36	17.2	56	0.3Stroke+3	146	68	108	137	152			
φ 25	20	8	4	6.8	28	102	3.2	40	55	45	135	36	17.2	60		150	68	108	141	156			
φ 30	20	8	4	6.8	28	104	3.2	40	55	45	137	36	17.2	60	0.25Stroke+3	152	70	110	143	158			
φ 40	23	12	4	7.0	30	134	3.2	55	75	50	173	40	19.2	67		190	94	140	179	190			

ACP

APM

AS

AX

AM2

AM

AL
ALX

AQ
ADQ

AQ2
ADQ2

AJ
AJM

ABK

ACK1

NSK

AG

NGQ

AGX
GX

NP

ADR

AMR

NDM

ARD

NST

AST

ASTH

NLCD

NLCS

Series AS

Double Acting (Front Flange Type/ASF○)

Lube Type(ASF), Non-Lube Type(ASFN), Air-Hydro Type(ASFH)

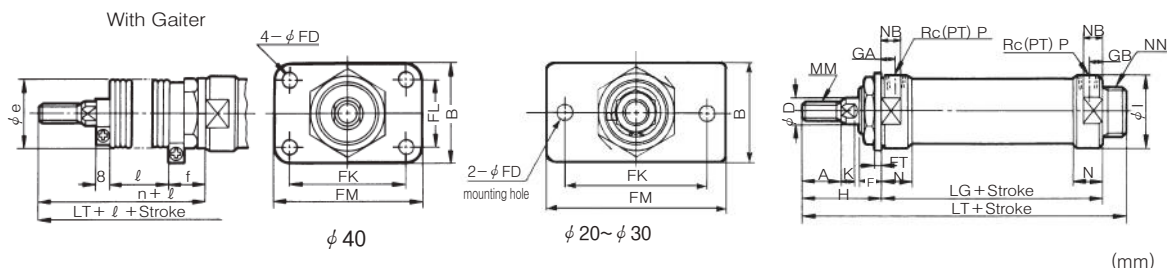

Bore size (mm)	*Stroke range (mm)	Effective length thread	A	B	φ D	F	GA	GB	φ I	K	MM	N	NA	NB	NN	P	LG
φ 20	~400	15.5	18	40	10	13	8	8	28	5.0	M8×1.25	15	24	13	M20×1.5	1/8	62
φ 25	~450	19.5	22	42	12	13	8	8	34	5.5	M10×1.25	15	30	13	M26×1.5	1/8	62
φ 30	~450	19.5	22	42	12	13	8	8	38	5.5	M10×1.25	15	32	13	M26×1.5	1/8	64
φ 40	~500	21.0	24	52	16	16	11	11	50	7.5	M14×1.5	21	46	19	M32×2.0	1/4	88

With Rubber Cushion

Bore size (mm)	φ FD	FT	FK	FL	FM	Without Rod Boot		With Rod Boot				Without Rod Boot		With Rod Boot	
						H	LT	φ e	f	h	ℓ	LT	LG	LT	LT
φ 20	7	3.2	60	-	75	41	116	36	17.2	56	0.3 Stroke+3	131	68	122	137
φ 25	7	4.5	60	-	75	45	120	36	18.5	60		135	68	126	141
φ 30	7	4.5	60	-	75	45	122	36	18.5	60		137	70	128	143
φ 40	7	4.5	66	36	82	50	154	40	20.5	67	0.25 Stroke+3	171	94	160	177

※ Minimum stroke with Rod Boot : 20mm or more.

Double Acting(Rear Flange Type/ASG○)

Lube Type(ASG), Non-Lube Type(ASGN), Air - Hydro Type(ASGH)

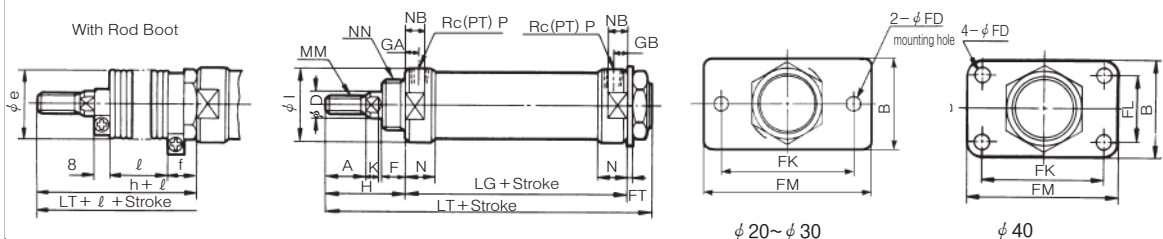

Bore Size (mm)	Stroke range (mm)	Effective length thread	A	B	φ D	F	GA	GB	φ I	K	MM	N	NA	NB	NN	P	LG
φ 20	~300	15.5	18	40	10	13	8	8	28	5.0	M8×1.25	15	24	13	M20×1.5	1/8	62
φ 25	~300	19.5	22	42	12	13	8	8	34	5.5	M10×1.25	15	30	13	M26×1.5	1/8	62
φ 30	~300	19.5	22	42	12	13	8	8	38	5.5	M10×1.25	15	32	13	M26×1.5	1/8	64
φ 40	~300	21.0	24	52	16	16	11	11	50	7.5	M14×1.5	21	46	19	M32×2.0	1/4	88

With Rubber Cushion

Bore size (mm)	φ FD	FT	FK	FL	FM	Without Rod Boot		With Rod Boot				Without Rod Boot		With Rod Boot	
						H	LT	φ e	f	h	ℓ	LT	LG	LT	LT
φ 20	7	3.2	60	-	75	41	116	36	14	56	0.3 Stroke+3	131	68	122	137
φ 25	7	4.5	60	-	75	45	120	36	14	60		135	68	126	141
φ 30	7	4.5	60	-	75	45	122	36	14	60		137	70	128	143
φ 40	7	4.5	66	36	82	50	154	40	16	67	0.25 Stroke+3	171	94	160	177

Series AS

Double Acting (Single Clevis Type/ASCO)

Lube Type(ASC), Non-Lube Type(ASCN), Air-Hydro Type(ASCH)

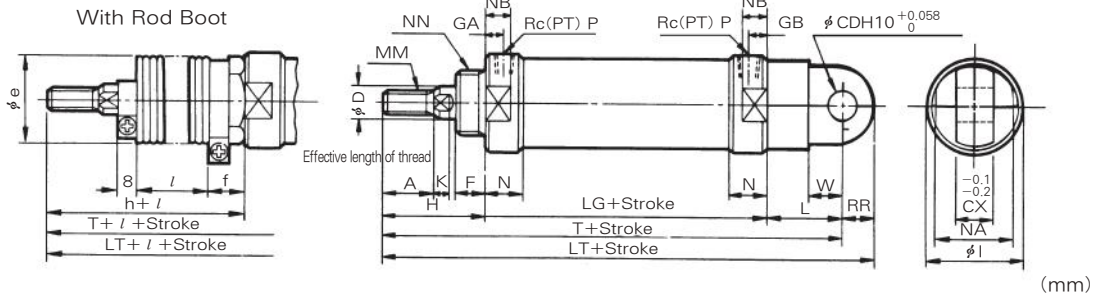

Bore size (mm)	Stroke range (mm)	Effective length of thread (mm)	A	φD	F	GA	GB	φI	K	L	MM	N	NA	NB	NN	P	LG
φ20	~300	15.5	18	10	13	8	8	28	5.0	30	M8×1.25	15	24	13	M20×1.5	1/8	62
φ25	~300	19.5	22	12	13	8	8	34	5.5	30	M10×1.25	15	30	13	M26×1.5	1/8	62
φ30	~300	19.5	22	12	13	8	8	38	5.5	30	M10×1.25	15	32	13	M26×1.5	1/8	64
φ40	~300	21.0	24	16	16	11	11	50	7.5	39	M14×1.5	21	46	19	M32×2.0	1/4	88

With Rubber Cushion

Bore size (mm)	W	φCD	CX	RR	Without Rod Boot						With Rod Boot				Without Rod Boot			With Rod Boot		
					H	T	LT	φe	f	h	l	T	LT	LG	T	LT	LG	T	LT	
φ20	14	9	10	9	41	133	142	36	14	56	0.3 Stroke+3	148	157	68	139	148	154	163		
φ25	14	9	10	9	45	137	146	36	14	60		152	161	68	143	152	158	167		
φ30	14	9	10	9	45	139	148	36	14	60	154	163	70	145	154	160	169			
φ40	18	10	15	11	50	177	188	40	16	67	0.25Stroke+3	194	205	94	183	194	200	211		

※ Minimum stroke with Rod Boot : 20mm or more.

Double Acting(Double Clevis Type/ASDO)

Lube Type(ASD), Non-Lube Type(ASDN), Air-Hydro Type(ASDH)

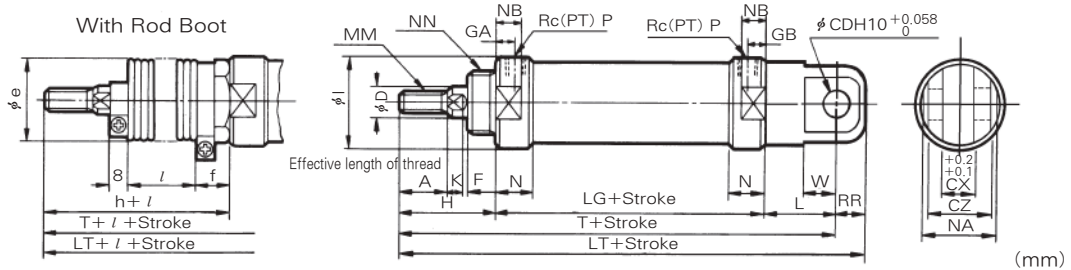

Bore size (mm)	Stroke range (mm)	Effective length of thread (mm)	A	φD	F	GA	GB	φI	K	L	MM	N	NA	NB	NN	P	LG
φ20	~300	15.5	18	10	13	8	8	28	5.0	30	M8×1.25	15	24	13	M20×1.5	1/8	62
φ25	~300	19.5	22	12	13	8	8	34	5.5	30	M10×1.25	15	30	13	M26×1.5	1/8	62
φ30	~300	19.5	22	12	13	8	8	38	5.5	30	M10×1.25	15	32	13	M26×1.5	1/8	64
φ40	~300	21.0	24	16	16	11	11	50	7.5	39	M14×1.5	21	46	19	M32×2.0	1/4	88

※ ※ Minimum stroke with Rod Boot : 20mm or more.

With Rubber Cushion

Bore size (mm)	W	φCD	CX	CZ	RR	Without Rod Boot						With Rod Boot				Without Rod Boot			With Rod Boot		
						H	T	LT	φe	f	h	l	T	LT	LG	T	LT	LG	T	LT	
φ20	14	9	10	19	9	41	133	142	36	14	56	0.3 Stroke+3	148	157	68	139	148	154	163		
φ25	14	9	10	19	9	45	137	146	36	14	60		152	161	68	143	152	158	167		
φ30	14	9	10	19	9	45	139	148	36	14	60	154	163	70	145	154	160	169			
φ40	18	10	15	30	11	50	177	188	40	16	67	0.25 Stroke+3	194	205	94	183	194	200	211		

ACP

APM

AS

AX

AM2

AM

AL
ALX

AQ
ADQ

AQ2
ADQ2

AJ
AJM

ABK

ACK1

NSK

AG

NGQ

AGX
GX

NP

ADR

AMR

NDM

ARD

NST

AST

ASTH

NLCD

NLCS

Series AS

Double Acting (Rear Trunnion/AST○)

Lube Type(AST), Non-Lube Type(ASTN), Air-Hydro Type(ASTH)

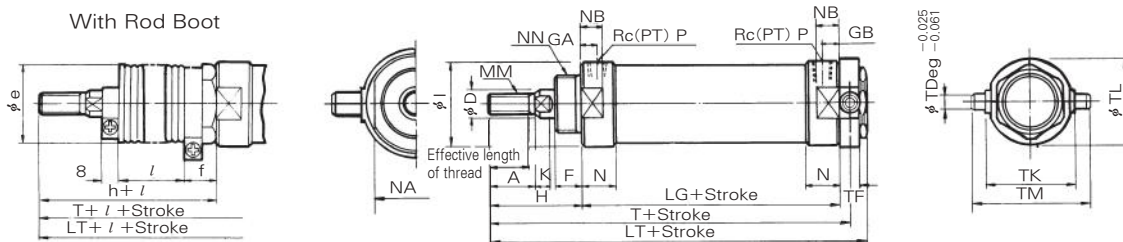

(mm)

Bore size (mm)	Stroke range (mm)	Effective length of thread	A	φD	F	GA	GB	φl	K	MM	N	NA	NB	NN	P	LG
φ20	~300	15.5	18	10	13	8	8	28	5.0	M8×1.25	15	24	13	M20×1.5	1/8	62
φ25	~300	19.5	22	12	13	8	8	34	5.5	M10×1.25	15	30	13	M26×1.5	1/8	62
φ30	~300	19.5	22	12	13	8	8	38	5.5	M10×1.25	15	32	13	M26×1.5	1/8	64
φ40	~300	21.0	24	16	16	11	11	50	7.5	M14×1.5	21	46	19	M32×2.0	1/4	88

Bore size (mm)	φTD	TF	TK	φTL	TM	Without Rod Boot			With Rod Boot					
						H	T	LT	φe	f	h	l	T	LT
φ20	8	10	32	32	52	41	108.0	118	36	14	56	0.3Stroke+3	123.0	133
φ25	9	10	40	40	60	45	112.0	122	36	14	60		127.0	137
φ30	9	10	40	40	60	45	114.0	124	36	14	60		129.0	139
φ40	10	11	53	53	77	50	143.5	154	40	16	67	0.25Stroke+3	160.5	171

With Rubber Cushion

LG	T	LT
68	114	124
68	118	128
70	120	130
94	169.5	160

Double Acting (Front Trunnion/ASU○)

Lube Type(ASU), Non-Lube Type(ASUN), Air-Hydro Type(ASUH)

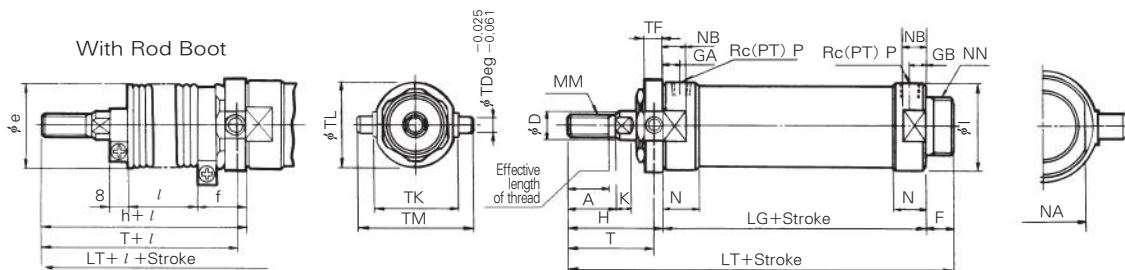

(mm)

Bore size (mm)	Stroke range (mm)	Effective length of thread	A	φD	F	GA	GB	φl	K	MM	N	NA	NB	NN	P	LG
φ20	~300	15.5	18	10	13	8	8	28	5.0	M8×1.25	15	24	13	M20×1.5	1/8	62
φ25	~300	19.5	22	12	13	8	8	34	5.5	M10×1.25	15	30	13	M26×1.5	1/8	62
φ30	~300	19.5	22	12	13	8	8	38	5.5	M10×1.25	15	32	13	M26×1.5	1/8	64
φ40	~300	21.0	24	16	16	11	11	50	7.5	M14×1.5	21	46	19	M32×2.0	1/4	88

Bore size (mm)	φTD	TF	TK	φTL	TM	Without Rod Boot			With Rod Boot					
						H	T	LT	φe	f	h	l	T	LT
φ20	8	10	32	32	52	41	36	116	36	21	56	0.3Stroke+3	51.0	131
φ25	9	10	40	40	60	45	40	120	36	21	60		55.0	135
φ30	9	10	40	40	60	45	40	122	36	21	60		55.0	137
φ40	10	11	53	53	77	50	44.5	154	40	24	67	0.25Stroke+3	61.5	171

With Rubber Cushion

LG	T	LT
68	36	122
68	40	126
70	40	128
94	44.5	160

Series AS

(mm)

I Type Single Knuckle Joint

TI-02 · TI-03

Material : Rolled steel sheet

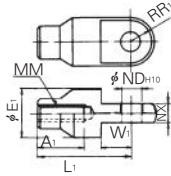

TI-04

Material : Free cutting sulfur steel

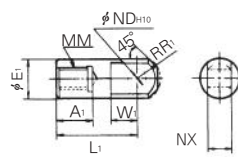

Parts No.	Applicable bore size(mm)	A1	E1	L1	MM	R1	W1	φ ND _{H10}	NX
TI-020B	20	16	20	36	M8×1.25	10	14	9 ^{+0.058} ₀	9 ^{-0.1} _{-0.2}
TI-032B	25 · 32	18	20	38	M10×1.25	10	14	9 ^{+0.058} ₀	9 ^{-0.1} _{-0.2}
TI-040B	40	22	24	55	M14×1.5	15.5	20	12 ^{+0.070} ₀	16 ^{-0.1} _{-0.3}

Y Type Double Knuckle Joint

TY-020B, TY-032B

Material : Rolled steel sheet

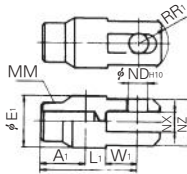

TY-040B

Material : Cast Iron

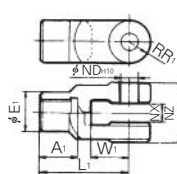

Parts No.	Applicable bore size(mm)	A1	E1	L1	MM	R1	W1	φ ND _{H10}	NX	NZ
TY-020B	20	16	20	36	M8×1.25	12	14	9 ^{+0.058} ₀	9 ^{+0.2} _{+0.1}	18
TY-032B	25 · 32	18	20	38	M10×1.25	12	14	9 ^{+0.058} ₀	9 ^{+0.2} _{+0.1}	18
TY-040B	40	22	24	55	M14×1.5	13	25	12 ^{+0.070} ₀	16 ^{+0.3} _{+0.1}	38

Pin For Clevis-Pin For Knuckle

Applicable : φ20, φ25, φ30

TCDP-1

Material : Carbon steel

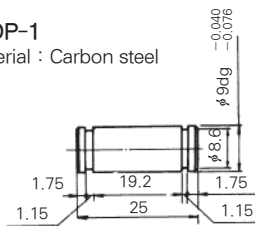

Retaining ring : C-9 type for pivot

Applicable : φ40(1.58)

TCDP-2
(for Clevis)

Material : Carbon steel

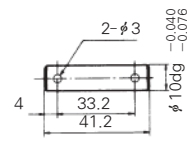

TCDP-3
(for Knuckle)

Material : Carbon steel

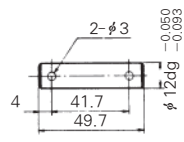

Applicable split pin : φ3×18 l

Mounting Nut(trunnion type only)

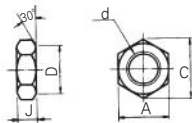

Material : rolled steel

Part No.	Applicable bore size(mm)	d	J	A	C	D
TN-020B	20	M20×1.5	10	26	28	25.5
TN-032B	25 · 30	M26×1.5	10	32	34	31.5
TN-040B	40	M32×2.0	10	41	45	40.5

Mounting Nut

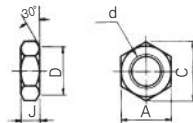

Material : Carbon steel

Part No.	Applicable bore size(mm)	d	J	A	C	D
TSN-020B	20	M20×1.5	8	26	30	25.5
TSN-032B	25 · 30	M26×1.5	8	32	37	31.5
TSN-040B	40	M32×2.0	10	41	47.3	40.5

Rod End Nut

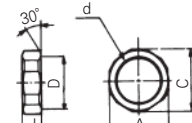

Material : rolled steel

Part No.	Applicable bore size(mm)	d	J	A	C	D
TN-02	20	M8×1.25	5	13	15.0	12.5
TN-03	25 · 30	M10×1.25	6	17	19.6	16.5
TN-04	40	M14×1.5	8	22	25.4	21.0

ACP

APM

AS

AX

AM2

AM

AL
ALX

AQ
ADQ

AQ2
ADQ2

AJ
AJM

ABK

ACK1

NSK

AG

NGQ

AGX
GX

NP

ADR

AMR

NDM

ARD

NST

AST

ASTH

NLCD

NLCS

Series ASW

Double Rod Type / Double Acting

Bore Size(mm) : Ø20, Ø25, Ø30, Ø40



- LONG CYCLE LIFE
- AUTO SWITCH CAN BE MOUNTED TO MONITOR STROKE POSITION
- COMPACT/AFFORDABLE DESIGN
- REPAIRABLE

Symbol

Double acting/Double rod

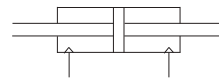

How to Order

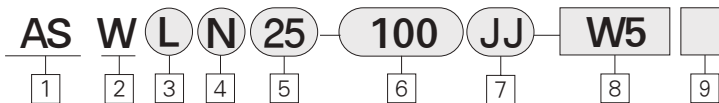

1 Air Cylinder Standard
(Built-in magnet)

2 Double Rod End Cylinder

3 Mounting

- B : Basic
- L : Foot
- F : Flange
- T : Rear Trunnion
- U : Front Trunnion

4 Type

- Blank : Lube
- N : Non-Lube
- H : Air-Hydro

5 Bore Size

- 20 : Ø20
- 25 : Ø25
- 30 : Ø30
- 40 : Ø40

6 Stroke(mm)

- 20, 25, 30, 40 : 25, 50, 75
- 100, 125, 150, 200, 250, 300

7 Suffix Symbol for Cylinder

C : Rubber Cushion

※ "LG", "LT" Size : Rubber Cushion type is longer than standard type(6mm more).

<Rod Boot>

- J : Nylon Boot
- K : Neoprene Cloth

<Double>

- JJ : Nylon Boot
- KK : Neoprene Cloth

8 Auto Switch

- W5 : Reed switch, 0.5m Lead wire
- W5L : Reed switch, 3m Lead wire

9 Number of Auto Switches

- Blank : 2 pcs
- S : 1 pc
- N : N pcs

Weight

kgf(lbf)

Bore size		Ø 20	Ø 25	Ø 30	Ø 40
Basic weight	Basic	0.20(0.49)	0.31(0.66)	0.34(0.75)	0.80(1.76)
	Foot	0.32(0.71)	0.41(0.90)	0.45(0.99)	0.99(2.18)
	Flange	0.23(0.51)	0.33(0.73)	0.37(0.82)	0.84(1.85)
	Trunnion	0.22(0.49)	0.34(0.75)	0.38(0.84)	0.84(1.85)
Additional weight for each 2 of stroke		0.09(0.20)	0.14(0.29)	0.14(0.29)	0.24(0.53)
Metal accessories	Single knuckle joint	0.06(0.13)	0.06(0.13)	0.06(0.13)	0.23(0.73)
	Double knuckle joint(with pin)	0.07(0.15)	0.07(0.15)	0.07(0.15)	0.21(0.44)

Example

ASWL30-100

- Basic Weight 0.45(Foot Type · Ø30)
- Additional Weight 0.14/50^{mm}
- Stroke 100^{mm}
0.45+0.14×100/50=0.72kg

Series ASW

Basic Type/ASWB

Lube Type(ASWB), Non-Lube Type(ASWBN), Air-Hydro Type(ASWBH)

With Single Rod Boot

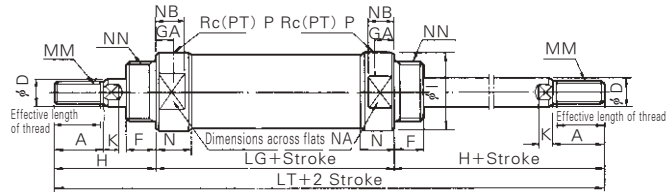
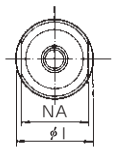
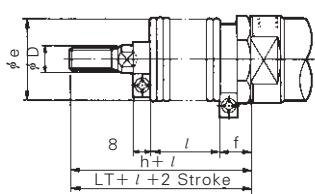

With Double Gaiter

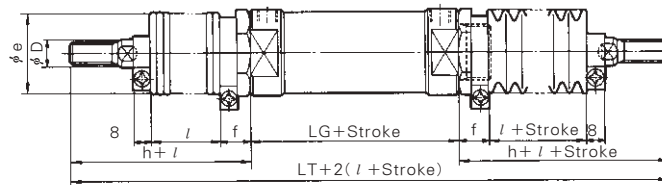

(mm)

Bore size (mm)	Stroke range(mm)		Effective length of thread	A	φD	F	GA	φI	K	MM	N	NA	NB	NN	P	LG
	Without Rod Boot	With Rod Boot														
φ20	~300	20~300	15.5	18	10	13	8	28	5	M8×1.25	15	24	13	M20×1.5	1/8	62
φ25	~300	20~300	19.5	22	12	13	8	34	5.5	M10×1.25	15	30	13	M26×1.5	1/8	62
φ30	~300	20~300	19.5	22	12	13	8	38	5.5	M10×1.25	15	32	13	M26×1.5	1/8	64
φ40	~300	20~300	21.0	24	16	16	11	50	7.5	M14×1.5	21	46	19	M32×2.0	1/4	88

With Rubber Cushion

Bore size (mm)	Without Rod Boot		With single Rod Boot					With double Rod Boot		LG	LT		
	H	LT	e	f	h	l	LT	LT	Without Rod Boot		With single Rod Boot	With Double Rod Boot	
φ20	41	144	36	14	56	0.3Stroke+3	159	174	68	150	165	180	
φ25	45	152	36	14	60		167	182	68	158	173	188	
φ30	45	154	36	14	60	0.25Stroke+3	169	184	70	160	175	190	
φ40	50	188	40	16	67		205	222	94	194	211	228	

ACP

APM

AS

AX

AM2

AM

AL
ALX

AQ
ADQ

AQ2
ADQ2

AJ
AJM

ABK

ACK1

NSK

AG

NGQ

AGX
GX

NP

ADR

AMR

NDM

ARD

NST

AST

ASTH

NLCD

NLCS

Series ASK

Non-rotating Rod Type/Double Acting, Single Acting

Bore Size(mm) : Ø20, Ø25, Ø30, Ø40



- AVAILABLE IN SERIES RANGING FROM Ø 20 THROUGH Ø 40
- HIGH NON-ROTATING ACCURACY
 Ø 20, Ø 25, Ø 30: ±0.8°
 Ø 40: ±0.5°
- LONG LIFE, HIGH SPEED OPERATION POSSIBLE
 Piston speed, 50~500 m/s, is same as standard type.
- AUTO SWITCH CAPABLE

Symbol

Double Acting Single Acting(Spring Return)

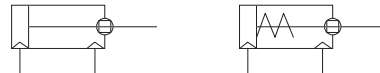

How to Order

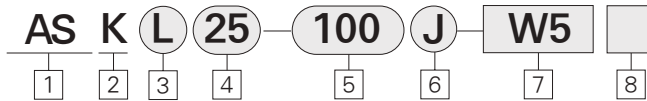

1 Air Cylinder

Built-in magnet, Non-Lube Standard

2 Non-Rotating Rod Type

3 Mounting

B : Basic
 L : Foot Mount
 F : Front Flange
 G : Rear Flange
 C : Single Clevis
 D : Double Clevis
 T : Rear Trunnion
 U : Front Trunnion

4 Bore Size

20 : Ø 20
 25 : Ø 25
 30 : Ø 30
 40 : Ø 40

5 Stroke/(mm)

Standard Stroke		
Type	Bore Size (mm)	Standard Stroke (mm)
Double Acting	20, 25	25, 50, 75, 100, 125
	30, 40	150, 200, 250, 300
Single Acting	20, 25	25, 50, 75, 100, 125, 150
	30	25, 50, 75, 100, 125, 150, 200
	40	50, 75, 100, 125, 150, 200, 250

6 Suffix Symbol for Cylinder

(Rod Boot)
 J : Nylon Tarpaulin
 K : Neoprene Cloth

(Action)

Blank : Double Acting
 S : Single Acting
 ※ Single Acting Spring extended type is not available.

7 Auto Switch

Blank : None
 W5 : Reed Switch, 0.5m Lead wire
 W5L : Reed Switch, 3m Lead wire

8 Number of Auto Switches

Blank : 2 pcs
 S : 1 pc
 N : N pcs

Series ASK

Specifications		
Action	Double Acting	Single Acting(Spring Return)
Medium	Air	
Proof Pressure	1.5MPa(21psi)	
Max. Operating Pressure	1.0MPa(14psi)	
Min. Operating Pressure	0.05MPa(7psi)	0.18MPa(25psi)
Ambient and Fluid Temperature	5~60°C(41~140°F)	
Piston Speed	50~500 mm/s	
Cushion	None / Rubber	
Stroke Tolerance	~250 st : +1.0 st , 251~300 st : +1.4 st	
Non-Rotating Accuracy	φ 20~φ 30 : ±0.8°, φ 40 : ±0.5°	
Mounting	Basic, Foot, Front Flange, Rear Flange, Single Clevis, Double Clevis, Rear Trunnion, Front Trunnion	

ACP

APM

AS

AX

AM2

AM

AL
ALXAQ
ADQAQ2
ADQ2AJ
AJM

ABK

ACK1

NSK

AG

NGQ

AGX
GX

NP

ADR

AMR

NDM

ARD

NST

AST

ASTH

NLCD

NLCS

Cautions

〈Installation〉

- Avoid applying rotational torque to piston rod in order to prevent deformation of the non-rotation guide.

Allowable rotating torque range for piston rod or less (kgf · cm)	φ 20	φ 25	φ 30	φ 40
	2.0	2.5	2.5	4.5

- Load of piston rod should always be aligned parallel, with the cylinder axis.
- Avoid loading the single acting cylinder rod during retraction.
- Lubrication is not required, however, use non-additive turbine oil ISO VG 32 if lubrication is supplied.

〈Installation piping〉

- Retract the rod fully before applying any kind of tightening torque on the end nut, Prevent torque being transmitted to the guide bushing by holding the rod stationary with a spanner on the flats.
- Flush tubing and fittings completely with clean air before use.
- When disassembling, hold one head cover on the flats with a vise while gripping the opposite cover on the flats with a spanner and turning counterclockwise.

When re-assembling, tighten by giving an additional turn of 3°~5° from the point where dissembled.

Series ASK

Basic Type/ASKB

Lube Type(ASKB), Non-lube Type(ASKBN), Air-hydro Type(ASKBH)

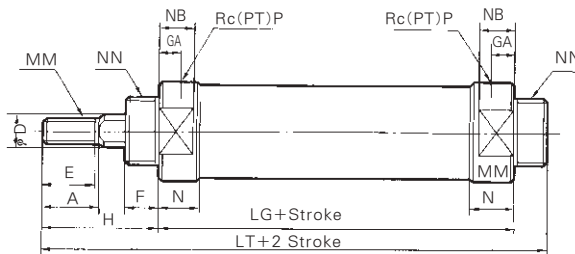
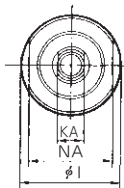
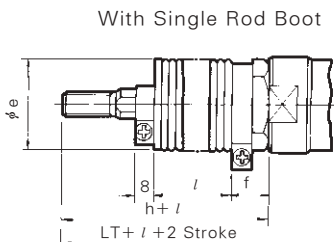

Double Acting

(mm)

Bore size (mm)	Stroke range(mm)		Effective length of thread E	A	ϕD	F	GA	ϕl	KA	MM	N	NA	NB	NN	P	LG
	Without Rod Boot	With Rod Boot														
20	~300	20~300	15.5	18	10	13	8	28	8	M8×1.25	15	24	13	M20×1.5	1/8	62
25	~300	20~300	19.5	22	12	13	8	34	10	M10×1.25	15	30	13	M26×1.5	1/8	62
30	~300	20~300	19.5	22	12	13	8	38	10	M10×1.25	15	32	13	M26×1.5	1/8	64
40	~300	20~300	21.0	24	16	16	11	50	14	M14×1.5	21	46	19	M32×2.0	1/4	88

With Rubber Cushion

Bore size (mm)	Without Rod Boot		With single Rod Boot					Without Rod Boot		With Rod Boot
	H	LT	ϕe	f	h	l	LT	LG	LT	LT
20	41	116	36	14	56	0.3Stroke+3	131	68	122	137
25	45	120	36	14	60		135	68	126	141
30	45	122	36	14	60		137	70	128	143
40	50	154	40	16	67	0.25Stroke+3	171	94	160	177

Single Acting

Bore size (mm)	Stroke Range (mm)	A	ϕD	F	GB	ϕl	KA	MM	N	NA	NB	NN	P	H
20	~150	18	10	13	8	28	8	M8×1.25	15	24	13	M20×1.5	1/8	41
25	~150	22	12	13	8	34	10	M10×1.25	15	30	13	M26×1.5	1/8	45
30	~200	22	12	13	8	38	10	M10×1.25	15	32	13	M26×1.5	1/8	45
40	~250	24	16	16	11	50	14	M14×1.5	21	46	19	M32×2.0	1/4	50

Bore size (mm)	25 st		50 st		75 st		100 st		125 st		150 st		200 st		250 st	
	LG	LT	LG	LT	LG	LT	LG	LT	LG	LT	LG	LT	LG	LT	LG	LT
20	84	138	102	156	126	180	144	198	169	223	194	248	-	-	-	-
25	82	140	97	155	119	177	134	192	144	202	159	217	-	-	-	-
30	87	145	104	162	124	182	150	208	167	225	187	245	227	285	-	-
40	123	189	123	189	136	202	153	219	174	240	191	257	221	287	246	312

Order Made Option

Adjustable Stroke Cylinder/Extension Adjustable Type

AS (Mounting Type) (Bore size) - (Stroke) (Additional symbol) (Stroke adjusting symbol) - XC8

Additional symbol ●

- Blank — Without Rod Boot
- J — With Rod Boot(Nylon tarpaulin)
- K — With Rod Boot(Neoprene cloth)

The Stroke at extend of the cylinder can be adjusted by the stopper in the head side from full stroke(0~25mm) or (0~50mm).

Stroke adjusting symbol ●

- A — Stroke adjusting range 0~25mm
- B — Stroke adjusting range 0~50mm

The cylinder stroke can be variably adjusted. The stroke adjustment device is fixed at the head side, and the cylinder stroke is adjusted by the stroke on the outlet side.

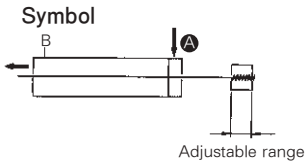

Construction, Dimensions/Basic Type

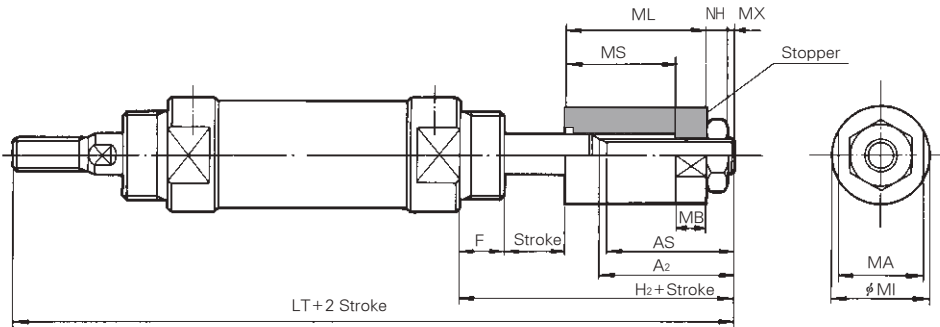

Bore size(mm)	A ₂	AS	ML	MA	MB	MS	φMI	NH	MX	H ₂	LT	stroke range
φ20	44(69)	41.5(66.5)	40(65)	14	9	32(57)	17	5	3	61(86)	164(189)	~300
φ25	45(70)	42.5(67.5)	40(65)	19	11	32(57)	24	6	3	62(87)	169(194)	~300
φ30	45(70)	42.5(67.5)	40(65)	19	11	32(57)	24	6	3	62(87)	171(196)	~300
φ40	51(77)	48(74)	44(70)	27	13	33(58)	30	8	3	71(97)	209(235)	~300

() : Stroke Adjusting range!50mm

ACP

APM

AS

AX

AM2

AM

AL
ALX

AQ
ADQ

AQ2
ADQ2

AJ
AJM

ABK

ACK1

NSK

AG

NGQ

AGX
GX

NP

ADR

AMR

NDM

ARD

NST

AST

ASTH

NLCD

NLCS

Order Made Option

Adjustable Stroke Cylinder/Retraction Adjustable Type

AS (Mounting) (Type) (Bore size) - (Stroke) (Additional symbol) (Stroke adjusting symbol) - XC9

Additional symbol

- Blank — Without Rod Boot
- J — With Rod Boot(Nylon tarpaulin)
- K — With Rod Boot(Neoprene cloth)
- C — Rubber Cushion

Stroke adjusting symbol

- A — Stroke adjusting range 0~25mm
- B — Stroke adjusting range 0~50mm

The Stroke at retraction of the cylinder can be adjusted from (0~25mm) or (0~50 mm) by the adjusting bolt.

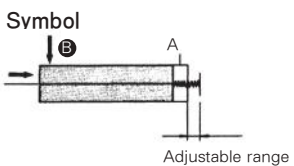

※ For Adjustable stroke Cylinder (Retraction Adjustable Type), inquire separately.

Construction, Dimensions/Basic Type

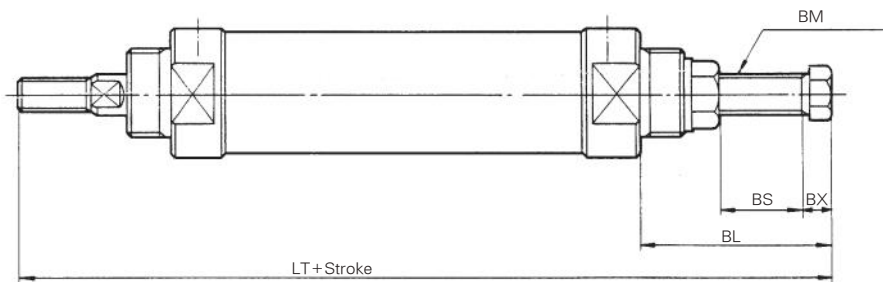

Bore size(mm)	BS	BM	BX	BL	LT
φ 20	29	M8×1.25	11	61	164
φ 25	33	M8×1.25	11	65	172
φ 30	31	M8×1.25	11	63	172
φ 40	28	M12×1.75	15	71	209

(mm)

Order Made Option

Dual Stroke Cylinder/Double Rod Type

AS (Mounting) (Type) (Bore size) - (Stroke A) (Additional symbol) + (Stroke B) (Adjusting symbol) - XC10

Additional symbol ●
 Blank — Without Rod Boot
 J — With Rod Boot(Nylon tarpaulin)
 K — With Rod Boot(Neoprene cloth)

Two cylinders are constructed as one cylinder in a back-to back configuration allowing the cylinder stroke to be controlled in three steps.

Construction, Dimensions/Basic Type

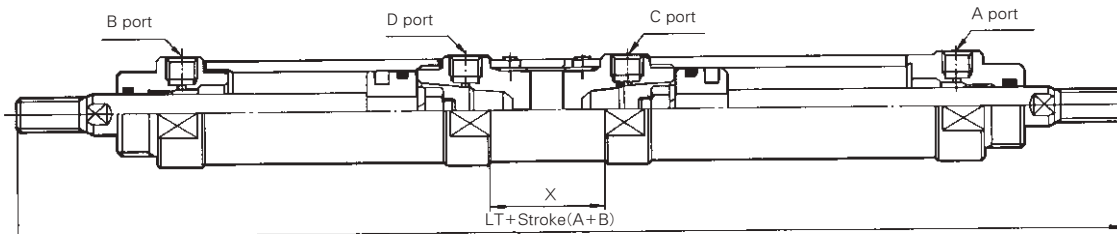

Bore size(mm)	X	LT
φ 20	28	234
φ 25	28	242
φ 30	28	246
φ 40	34	310

※ Other dimensions are the same for standard type.

Dual Stroke Cylinder/Single Rod Type

AS (Mounting) (Type) (Bore size) - (Stroke A) + (Stroke B-A) (Adjusting symbol) - XC11

Additional symbol ●
 Blank — Without Rod Boot
 J — With Rod Boot(Nylon tarpaulin)
 K — With Rod Boot(Neoprene cloth)

This cylinder is produced with two air cylinders in line allowing double the output force.

Construction, Dimensions/Basic Type

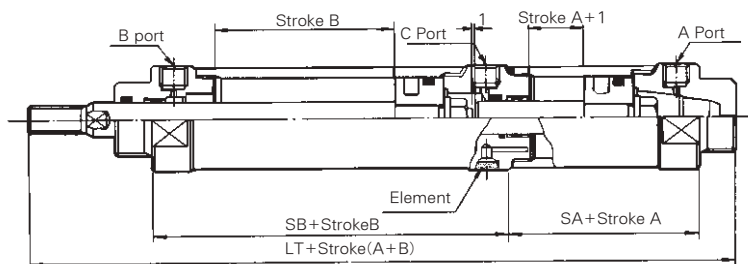

Bore size(mm)	SB	SA	LT
φ 20	62	48	164
φ 25	62	48	168
φ 30	64	50	172
φ 40	88	50	222

※ Other dimensions are the same for standard type.

- ACP
- APM
- AS**
- AX
- AM2
- AM
- AL
- ALX
- AQ
- ADQ
- AQ2
- ADQ2
- AJ
- AJM
- ABK
- ACK1
- NSK
- AG
- NGQ
- AGX
- GX
- NP
- ADR
- AMR
- NDM
- ARD
- NST
- AST
- ASTH
- NLCD
- NLCS

Order Made Option

Single Acting Spring Extended

AS (Mounting) (Type) (Bore size) (Stroke) - T

Specifications

Lube	Lube, Non-lube
Bore size	φ20, φ25, φ30, φ40
Max. operating pressure	1.0MPa(140psi)
Min. operating pressure	0.23MPa(32psi)
Cushion	None
Action	Spring extended
Mounting	basic type, Axial foot type, Head side, flange type, Single clevis type, Double clevis type, Head side trunnion, Rod side trunnion

High Temperature Cylinder

AS (Mounting) (Bore size) (Stroke) - XB6

Use at high temperature up to 150°C

※ Dimensions are the same as for standard type.

Boss Cut

AS (Mounting) (Type) (Bore size) (Stroke) (Suffix) - XC1

Boss for the head cover bracket is eliminated and the total length of cylinder is shortened.

Specifications

Type	Lube, Non-lube, Air-hydro
Bore size	φ20, φ25, φ30, φ40
Acting	Double, single
Mounting	Basic, Rod side flange, Rod side trunnion

Dimensions

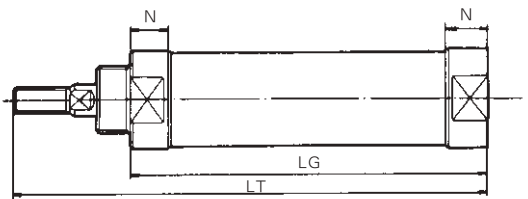

Bore size(mm)	20	25	30	40
LT	102	106	108	137
LG	61	61	63	87
N	14	14	14	20

※ Other dimensions are the same as for standard type

End Lock Cylinder

AS (Mounting) (Type) (Bore size) (Stroke) (Suffix) - X105

Specifications

Type	Lube, non-lube
Bore size	φ25, φ30, φ40
Cushion	None
Action	Double Acting
Retaining force	Max. 20kgf
Lock start pressure	0.05MPa(7psi)
Lock release pressure	0.2MPa(28psi)
Max. operating pressure	1.0MPa(140psi)

Stainless Steel Rod

AS (Mounting) (Type) (Bore size) (Stroke) (Suffix) - XC6

Stainless steel piston rod is used to protect in harsh or wet environment.

Auto-switch mounting available.

Specifications

Type	Lube, Non-lube, Air-hydro
Bore size	φ20, φ25, φ30, φ40
Piston rod nut material	Stainless steel

Tandem Air Cylinder

AS (Mounting) (Type) (Bore size) (Stroke) (Suffix) - XC12

This cylinder is produced with two air cylinders in line allowing double the output force.

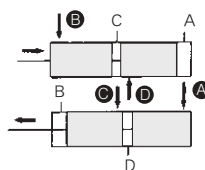

When air pressure is supplied to ports B and D, the output force is double in the return stroke.

When air pressure is supplied to ports A and C the output force is double in the return stroke.

Specifications

Lube	Lube, Non-lube
Bore size	φ20, φ25, φ30, φ40
Max. operating pressure	0.1MPa(14psi)
Min. operating pressure	0.08MPa(11psi)
Cushion	Air Cushion
operouting Type	Double acting
Mounting	Basic type, Axial foot type, Bod side, flange type, Single clevis type, Double clevis type, Head side flange type.