

# QUICK **NAC** COUPLINGS

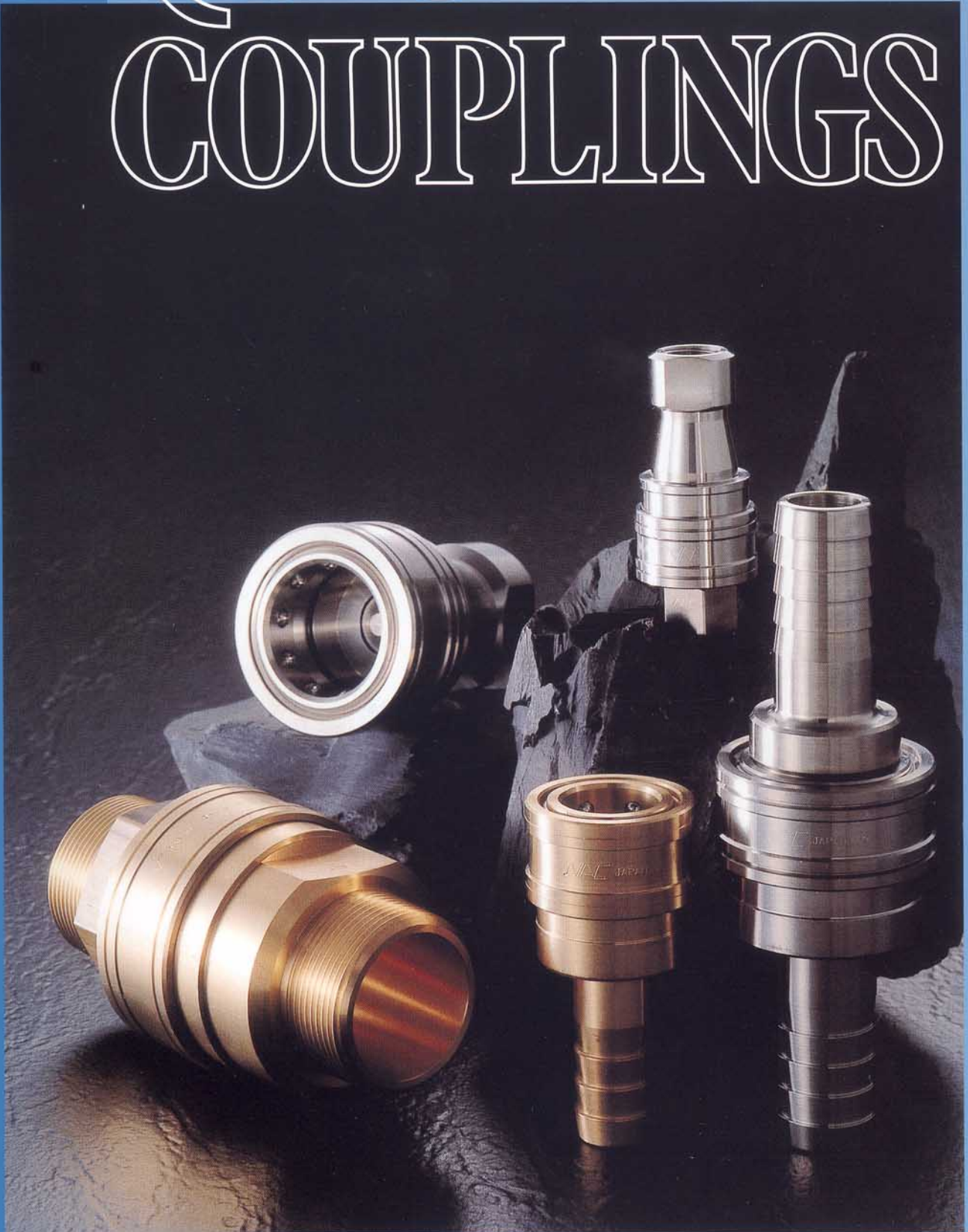

**NAGAHORI INDUSTRY CO.,LTD.**

We are ISO14001 certified in 2002 and ISO9001 in 2000.

# Product Number Guide

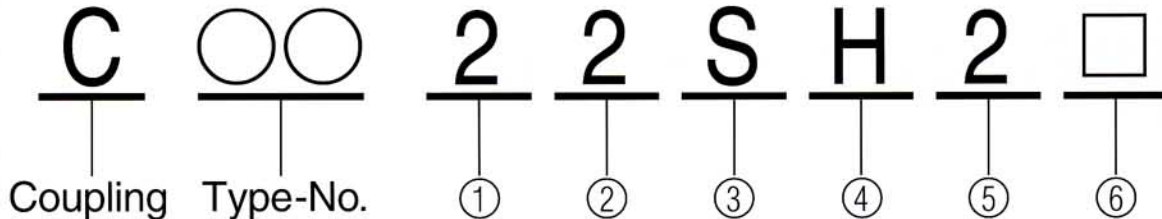

**①AL only    ②Size    ③Socket/Plug    ④Connection    ⑤Body Material    ⑥Addition**

1=10  
2=20  
4=40

1=01=1/8"  
2=02=1/4"  
3=03=3/8"  
4=04=1/2"  
6=06=3/4"  
8=08=1"  
10=11/4"  
12=11/2"  
16=2"

S=Socket  
P=Plug

H=Hose  
M=Male Thread  
F=Female Thread  
A=Nut  
B=Nut

No Mark  
(AL type)  
=Steel  
(chrome-plated)  
(TL,S-P,H-P type)  
=Steel  
(zinc-plated)  
  
2=Brass  
3=Stainless steel  
(SUS304)  
4=Stainless steel  
(SUS316)

L=Lock type  
V=Vacuum

<EXAMPLES>

(AL TYPE)

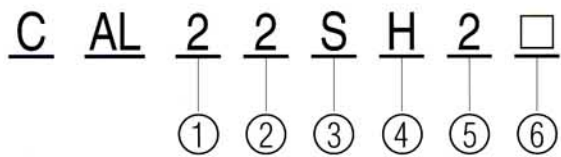

(TL TYPE)

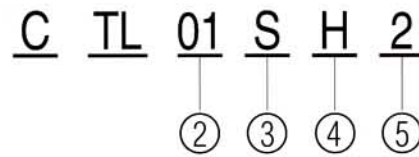

(S·P TYPE)

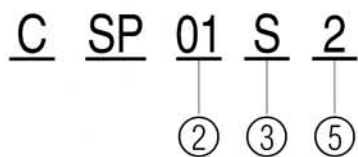

(H·P TYPE)

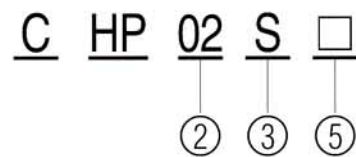

# QUICK COUPLING CAL TYPE

## SINGLE VALVE TYPE

■ SH-PH(Hose nipple) ■ SM-PM(Male thread) ■ SF-PF(Female thread)

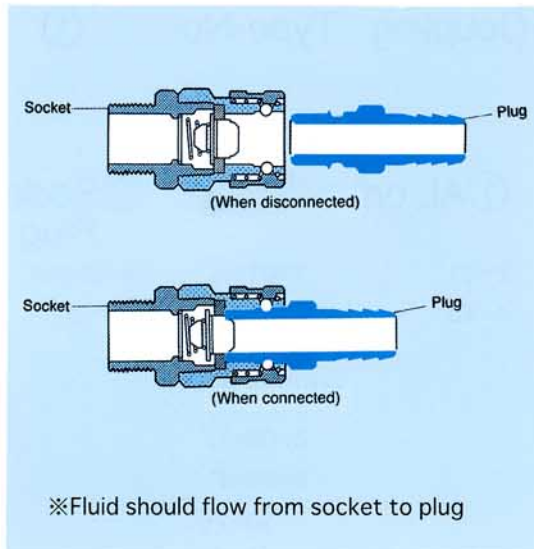
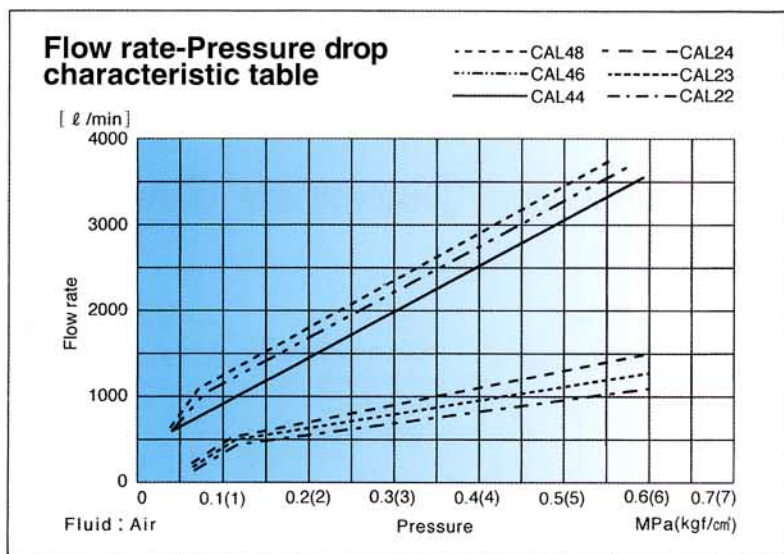

## <SPECIFICATION>

Type	20				40		
Model	CAL21	CAL22	CAL23	CAL24	CAL44	CAL46	CAL48
Nominal size	1/8"	1/4"	3/8"	1/2"	1/2"	3/4"	1"
Body material	Steel(chrome-plated), Brass, Stainless steel(SUS304)						
Connection	Socket	Female thread(F), Male thread(M)					
	Plug	Hose nipple(H)					
Nomal pressure MPa(kgf/cm <sup>2</sup> ) Max.pressure MPa(kgf/cm <sup>2</sup> )	Steel	Normal 1.5(15) Max.2.0(20)					
	Brass	Normal 1.0(10) Max.1.5(15)					
	Stainless steel	Normal 1.5(15) Max.2.0(20)					
packing material	Standard	Nitrile rubber (NBR): -20°C ~ +80°C					
	Option	Fluoro rubber (FPM): -20°C ~ +180°C					
Applicable fluid	Steel	Air, Oil, etc.					
	Brass	Air, Water, etc.					
	Stainless steel	Air, Water, etc.					
Applications	Air tools, Air piping, Water piping, etc.						

- Widely used and accepted couplings for air line connection.
- Important steel parts are hardened for high durability.
- Socket have automatic shut-off valve so that fluid in the socket will not run out on disconnection.

### Caution

- Types 20(CAL21, CAL22, CAL23 and CAL24 types) have sockets and plugs that can be interchanged and types 40 are the same, however between 20 and 40 can not be interchanged.
- For vibration or impact tools use, put intermediate hose (about 30 cm) between plug and tool.
- Fluid should flow from socket to plug.
- Do not use as swivels also force couplers continuously rotating.

# QUICK COUPLING CAL TYPE

## SOCKET

### SH for hose connection

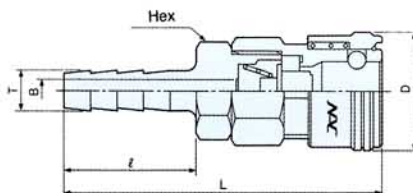

Type	Model	Application	Weight (g)			Dimension (mm)					
			Steel	Brass	Stainless	L	φ D	Hex	ℓ	φ B	φ T
20	CAL21SH	1/8" Hose	99	—	—	72.5	26.5	19	30	4.5	7.5
	CAL22SH	1/4" Hose	102	111	102	72.5	26.5	19	30	5	9
	CAL23SH	3/8" Hose	105	112	106	76.5	26.5	19	34	7.5	11.3
	CAL24SH	1/2" Hose	117	127	125	78.5	26.5	19	36	9	15
40	CAL44SH	1/2" Hose	234	235	213	84	36.5	29	36	9	15
	CAL46SH	3/4" Hose	266	259	239	93	36.5	29	45	13	21
	CAL48SH	1" Hose	287	293	292	103	36.5	29	55	20	27

### SM for female thread connection

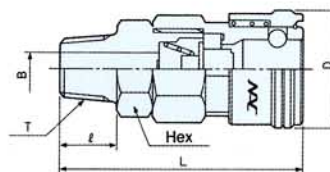

Type	Model	Application	Weight (g)			Dimension (mm)					
			Steel	Brass	Stainless	L	φ D	Hex	ℓ	φ B	T
20	CAL21SM	Rc 1/8	98	—	—	53.5	26.5	19	11	4	R 1/8
	CAL22SM	Rc 1/4	100	110	101	55.5	26.5	19	13	7	R 1/4
	CAL23SM	Rc 3/8	108	117	107	56.5	26.5	19	14	8	R 3/8
	CAL24SM	Rc 1/2	126	140	124	58.5	26.5	22	16	9	R 1/2
40	CAL44SM	Rc 1/2	224	227	207	64	36.5	29	16	13	R 1/2
	CAL46SM	Rc 3/4	248	261	227	66	36.5	32	18	16	R 3/4
	CAL48SM	Rc1	290	315	272	70	36.5	36	22	22	R1

### SF for male thread connection

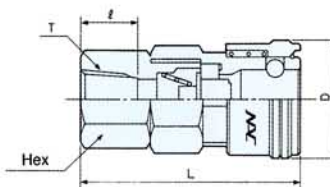

Type	Model	Application	Weight (g)			Dimension (mm)				
			Steel	Brass	Stainless	L	φ D	Hex	ℓ	T
20	CAL21SF	R 1/8	100	—	—	47.5	26.5	19	11.5	Rc 1/8
	CAL22SF	R 1/4	101	108	99	50.5	26.5	19	13	Rc 1/4
	CAL23SF	R 3/8	102	109	100	50.5	26.5	21	14	Rc 3/8
	CAL24SF	R 1/2	138	153	138	52.5	26.5	29	15	Rc 1/2
40	CAL44SF	R 1/2	229	231	212	58	36.5	29	15	Rc 1/2
	CAL46SF	R 3/4	263	278	230	60	36.5	35	17	Rc 3/4
	CAL48SF	R1	325	350	278	67	36.5	41	22	Rc1

**Note** Some dimensions for Body material Brass and Stainless are slightly different. Please ask us or our distributors if you need dimensions in details.

# QUICK COUPLING CAL TYPE

## PLUG

### ■ PH for hose connection

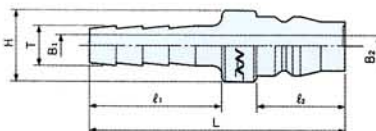

Type	Model	Application	Weight(g)			Dimension(mm)						
			Steel	Brass	Stainless	L	φ H	ℓ 1	ℓ 2	φ T	φ B1	φ B2
20	CAL21PH	1/8" Hose	26	—	—	58	16	30	20	7.5	4.5	7.5
	CAL22PH	1/4" Hose	30	30	28	58	16	30	20	9	5	7.5
	CAL23PH	3/8" Hose	33	33	33	62	16	34	20	11.3	7.5	7.5
	CAL24PH	1/2" Hose	60	63	58	64	20	36	20	15	7.5	7.5
40	CAL44PH	1/2" Hose	69	73	63	67	22	36	23	15	9	13
	CAL46PH	3/4" Hose	120	137	116	76	30	45	23	21	13	13
	CAL48PH	1" Hose	155	166	158	86	34	55	23	27	20	13

### ■ PM for female thread connection

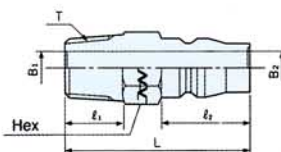

Type	Model	Application	Weight(g)			Dimension(mm)						
			Steel	Brass	Stainless	L	Hex	ℓ 1	ℓ 2	T	φ B1	φ B2
20	CAL21PM	Rc 1/8	24	25	23	39	14	11	20	R 1/8	4	7.5
	CAL22PM	Rc 1/4	26	29	26	42	14	13	20	R 1/4	7.5	7.5
	CAL23PM	Rc 3/8	44	48	44	43	19	14	20	R 3/8	7.5	7.5
	CAL24PM	Rc 1/2	60	65	64	46	22	16	20	R 1/2	12	7.5
40	CAL44PM	Rc 1/2	62	76	69	47	22	16	23	R 1/2	13	13
	CAL46PM	Rc 3/4	92	124	107	49	32	18	23	R 3/4	19	13
	CAL48PM	Rc 1	140	200	177	53	35	22	23	R 1	22	13

### ■ PF for male thread connection

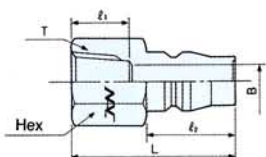

Type	Model	Application	Weight(g)			Dimension(mm)					
			Steel	Brass	Stainless	L	Hex	ℓ 1	ℓ 2	T	φ B
20	CAL21PF	R 1/8	22	—	—	33	14	11.5	20	Rc 1/8	7.5
	CAL22PF	R 1/4	30	32	31	37	17	13	20	Rc 1/4	7.5
	CAL23PF	R 3/8	40	43	39	38	21	14	20	Rc 3/8	7.5
	CAL24PF	R 1/2	81	79	69	39	29	15	20	Rc 1/2	7.5
40	CAL44PF	R 1/2	85	89	71	41	29	15	23	Rc 1/2	13
	CAL46PF	R 3/4	117	129	95	43	35	17	23	Rc 3/4	13
	CAL48PF	R 1	191	210	133	51	41	22	23	Rc 1	13

**Note** Some dimensions for Body material Brass and Stainless are slightly different. Please ask us or our distributors if you need dimensions in details.

# QUICK COUPLING CAL TYPE STEEL <chrome-plated>

## SINGLE VALVE NUT TYPE

### AL Nut

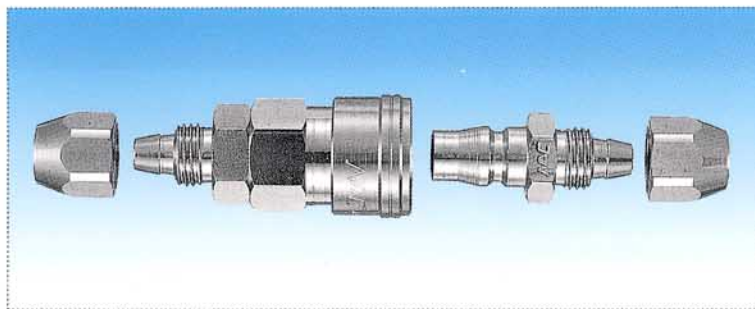

- Urethane hose connection, no hose clamps required.
- Same series as AL couplings 20 type interchangeable with their sockets and plugs.
- To fit coupling into hose, slide hose over nipple then tighten nut.
- Available with steel body only. Not suitable for water use.

## SOCKET · PLUG

### SA · SB

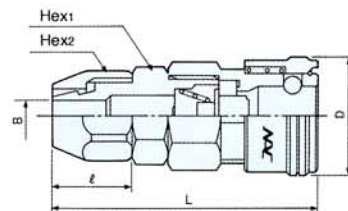

Type	Model	Hose size	Dimensions(mm)						Weight (gf)
		I.D.×O.D.	L	φ D	Hex1	Hex2	ℓ	φ B	
20	CAL21SA	5×8	57.5	26.5	19	14	15	4	105
	CAL22SA	6×9	60	26.5	19	17	17	4.8	112
	CAL22SB	6.5×10	60	26.5	19	17	17	5.3	112
	CAL23SA	8×12	62	26.5	19	19	20	7	120
	CAL23SB	8.5×21.5	62	26.5	19	19	19	7	120
	CAL24SA	11×16	67	26.5	23	24	25	10	162

### PA · PB

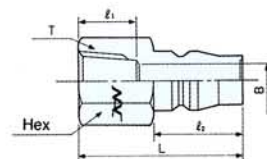

Type	Model	Hose size	Dimensions(mm)						Weight (gf)
		I.D.×O.D.	L	Hex	ℓ 1	ℓ 2	φ B1	φ B2	
20	CAL21PA	5×8	41.5	14	15	20	4	7.5	31
	CAL22PA	6×9	43.5	17	17	20	4.8	7.5	43
	CAL22PB	6.5×10	43.5	17	17	20	5.3	7.5	43
	CAL23PA	8×12	46	19	20	20	7	7.5	53
	CAL23PB	8.5×12.5	46	19	19	20	7	7.5	53
	CAL24PA	11×16	52	24	25	20	10	7.5	98

# QUICK COUPLING CAL TYPE BALL-LOCK STEEL <chrome-plated>

## SINGLE VALVE BALL-LOCK TYPE

- Ball lock mechanism prevents unexpected disconnection of socket and plug during normal use.
- Can be connected to AL series plugs type 20 likes 21, 22, 23 and 24.

## SOCKET

### ■ SHL (Hose nipple)

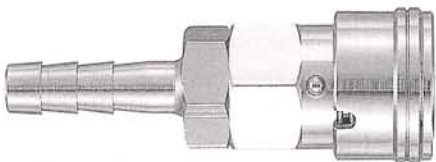

Type	Model	Hose size
20	CAL21SHL	1/8" Hose
	CAL22SHL	1/4" Hose
	CAL23SHL	3/8" Hose
	CAL24SHL	1/2" Hose

### ■ SML (Male thread)



Type	Model	Application
20	CAL21SML	Rc 1/8
	CAL22SML	Rc 1/4
	CAL23SML	Rc 3/8
	CAL24SML	Rc 1/2

### ■ SFL (Female thread)

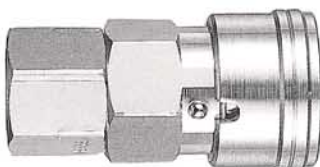

Type	Model	Application
20	CAL21SFL	R 1/8
	CAL22SFL	R 1/4
	CAL23SFL	R 3/8
	CAL24SFL	R 1/2

### ■ SAL · SBL (Nut)



Type	Model	Hose size I.D. × O.D.
20	CAL21SAL	5 × 8
	CAL22SAL	6 × 9
	CAL22SBL	6.5 × 10
	CAL23SAL	8 × 12
	CAL23SBL	8.5 × 12.5

# QUICK COUPLING CAL TYPE CAT20

## SINGLE VALVE ONE TOUCH TYPE

■ SH-PH (Hose nipple) ■ SM-PM (Male thread) ■ SF-PF (Female thread)

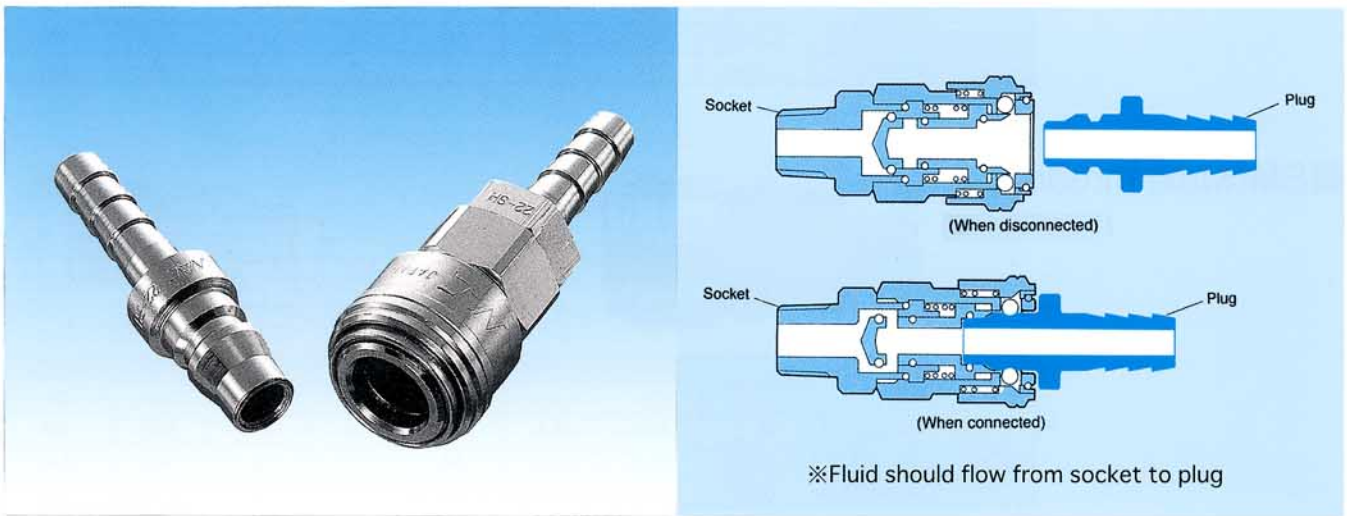

### <SPECIFICATION>

Type		CAT20			CAT20 Nut				
Model		CAT22	CAT23	CAT24	CAT21A	CAT22A	CAT23A	CAT22B	CAT23B
Nominal size		1/4"	3/8"	1/2"	φ5×φ8	φ6×φ9	φ8×φ12	φ6.5×φ10	φ8.5×φ12.5
Body material		Steel(Chrome-plated)							
Connection		Female thread(F), Male thread(M), Hose nipple(H), Nut(A · B)							
Nomal pressure MPa(kgf/cm <sup>2</sup> ) Max.pressure MPa(kgf/cm <sup>2</sup> )	Steel	Normal pressure 1.0(10) Max. pressure 1.5(15)							
	Packing material	Standard	Nitrile rubber (NBR): -20°C ~ +80°C						
	Option	Fluoro rubber (FPM): -20°C ~ +180°C							
Applicable fluid	Steel	Air, Oil, etc.							
Applications		Air tools, Air piping, Various air pressurized equipment							

- Fluid should flow from socket to plug.
- One hand operation allows fast and easy connection and disconnection.
- Can be connected to AL series plugs type 20 like 21, 22, 23 and 24.
- Available with steel body only. Not suitable for water use.



# QUICK COUPLING CAT TYPE STEEL < Chrome-plated >

## SOCKET

### SH (Hose nipple)

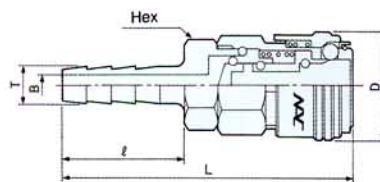

Type	Model	Hose size	Dimensions(mm)						Weight (gf)
			L	φ D	Hex	ℓ	φ B	φ T	
CAT20	CAT22SH	1/4" Hose	75.5	26.5	19	30	5	9	106
	CAT23SH	3/8" Hose	79.5	26.5	19	34	7.5	11.3	108
	CAT24SH	1/2" Hose	81.5	26.5	19	36	9	15	120

### SM (Male thread)

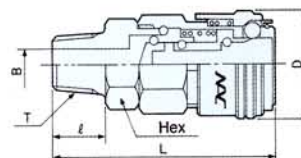

Type	Model	Application	Dimensions(mm)						Weight (gf)
			L	φ D	Hex	ℓ	φ B	φ T	
CAT20	CAT22SM	Rc 1/4"	58.5	26.5	19	13	7	R 1/4"	103
	CAT23SM	Rc 3/8"	59.5	26.5	19	14	8	R 3/8"	110
	CAT24SM	Rc 1/2"	62.5	26.5	22	16	9	R 1/2"	129

### SF (Female thread)

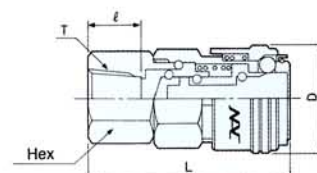

Type	Model	Application	Dimensions(mm)					Weight (gf)
			L	φ D	Hex	ℓ	T	
CAT20	CAT22SF	R 1/4"	53.5	26.5	19	13	Rc 1/4"	104
	CAT23SF	R 3/8"	53.5	26.5	21	14	Rc 3/8"	104
	CAT24SF	R 1/2"	55.5	26.5	29	15	Rc 1/2"	143

### SA · SB (Nut)

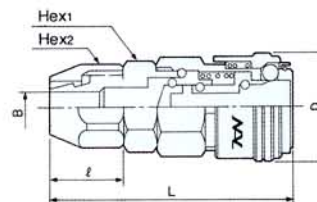

Type	Model	Hose size I.D. X O.D.	Dimensions(mm)						Weight (gf)
			L	φ D	Hex1	Hex2	ℓ	φ B	
CAT20	CAT21SA	5 × 8	60.5	26.5	19	14	15	4	98
	CAT22SA	6 × 9	63	26.5	19	17	17	4.3	115
	CAT22SB	6.5 × 10	63	26.5	19	17	17	5.3	114
	CAT23SA	8 × 12	65	26.5	19	19	20	7	124
	CAT23SB	8.5 × 12.5	65	26.5	19	19	19	7	121

# QUICK COUPLING CAT TYPE

## SINGLE VALVE ONE TOUCH & BALL LOCK TYPE

- One hand operation allows quick and easy connection and disconnection.
- Ball lock mechanism prevents unexpected disconnection of socket and plug during normal use.
- Can be connected to AL series plugs type 20 likes 21, 22, 23 and 24.

### SOCKET

#### ■ SHL (Hose nipple)



Type	Model	Hose size
CAT20	CAT22SHL	1/4" Hose
	CAT23SHL	3/8" Hose
	CAT24SHL	1/2" Hose

#### ■ SML (Male thread)



Type	Model	Application
CAT20	CAT22SML	Rc 1/4
	CAT23SML	Rc 3/8
	CAT24SML	Rc 1/2

#### ■ SFL (Female thread)



Type	Model	Application
CAT20	CAT22SFL	R 1/4
	CAT23SFL	R 3/8
	CAT24SFL	R 1/2

#### ■ SAL · SBL (Nut)



Type	Model	Hose size I.D. × O.D.
CAT20	CAT21SAL	5 × 8
	CAT22SAL	6 × 9
	CAT22SBL	6.5 × 10
	CAT23SAL	8 × 12
	CAT23SBL	8.5 × 12.5